



FMSS6 Fitting Instructions



Please thoroughly read through and familiarise yourself with these instructions in their entirety prior to beginning any part of the installation process of any component. Please also ensure the vehicle and engine has cooled down sufficiently to avoid risking possible skin burns or other injury.

TOOLS NEEDED:

Flat head screwdriver
10mm socket and ratchet
10 & 16mm spanner

1. Open the bonnet, using a 10mm socket and suitable drive remove the bolt as shown below.

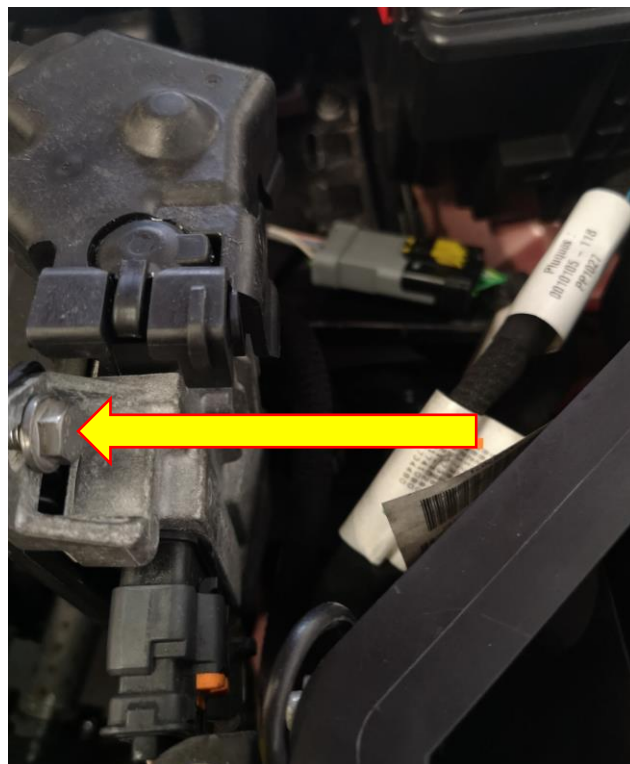

2. Gently lift the electronics unit off its mount on the OEM front airbox and move it slightly to the right. This will allow better access to the front airbox to remove it.
3. Using a flat head screwdriver pull the tab labelled A in the image below to the right of the vehicle and lift the OEM front airbox directly upwards to remove it. It is worth remembering how this component is attached for reassembly later. Labelled B in the image below are two slots on the OEM front airbox, these slot into C on the other image.

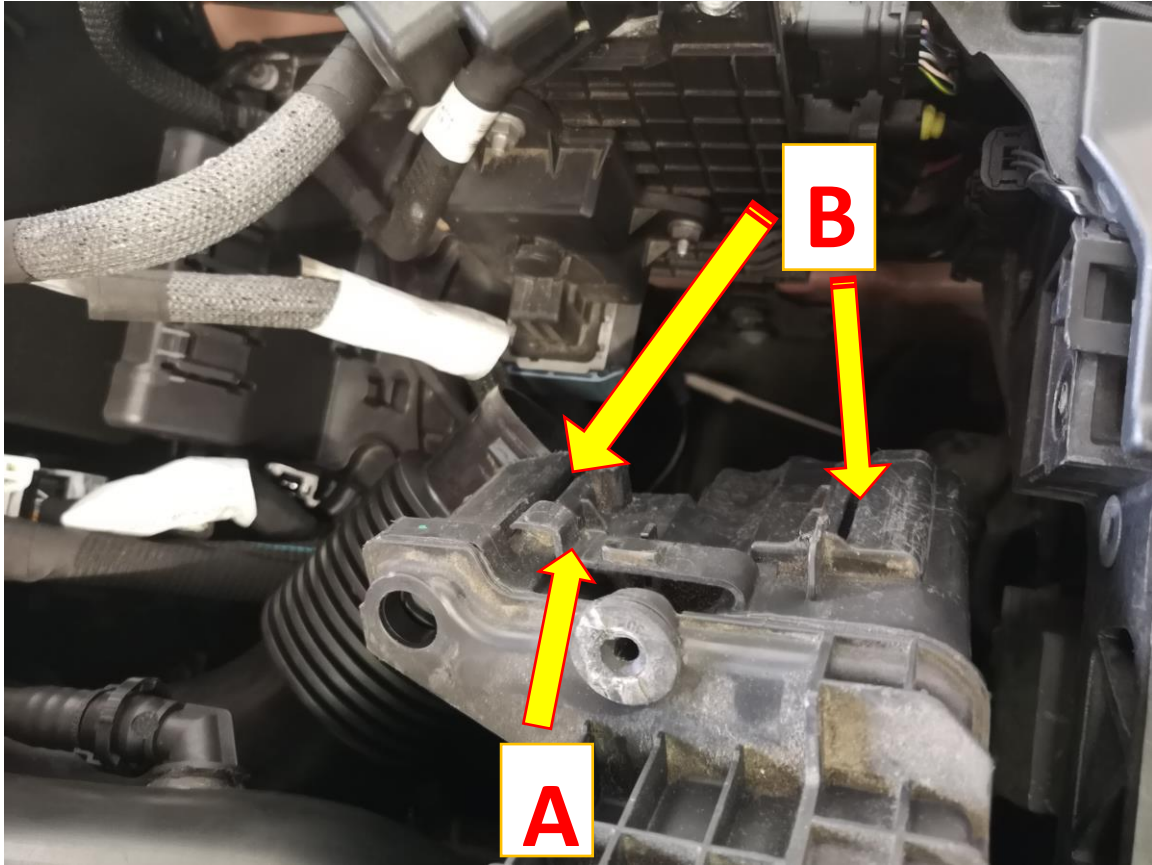

4. Now that the OEM front airbox is removed, and we have the electronics unit moved to the side you will be able to locate the OEM shifter mechanism.

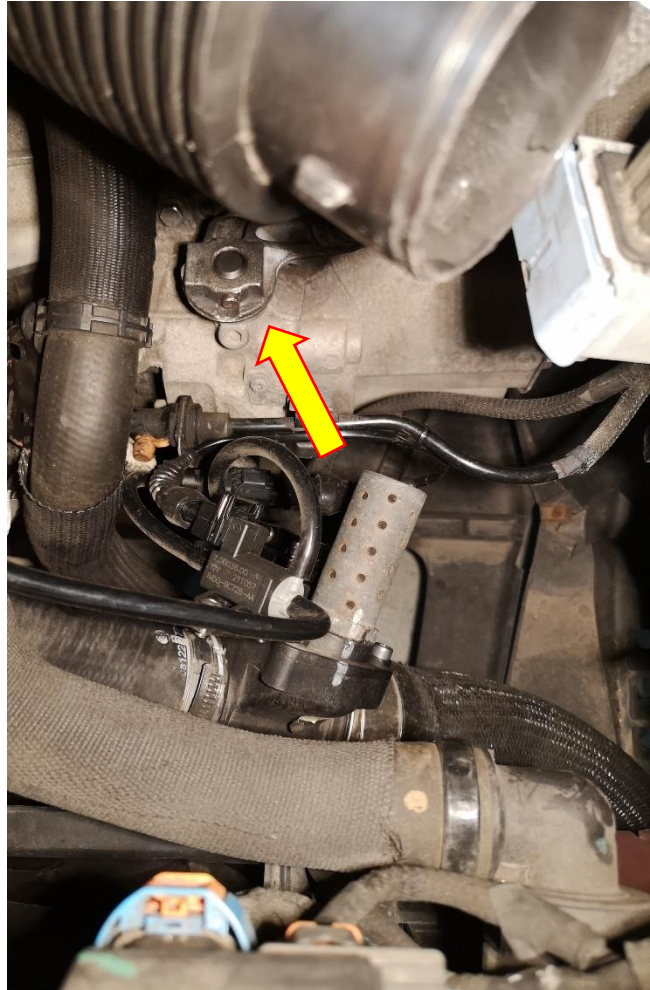

5. Pinch the white tabs on the selector cable and pull vertically to disconnect it from the mechanism.



- Using the supplied pin removal tool, align the bolt of the tool with the pin and wind the bolt with a 10mm socket and ratchet to push the pin out the back of the shifter shaft, then unwind the bolt out towards you so you are able to remove the pin removal tool. Pull the OE shifter upwards to remove it.

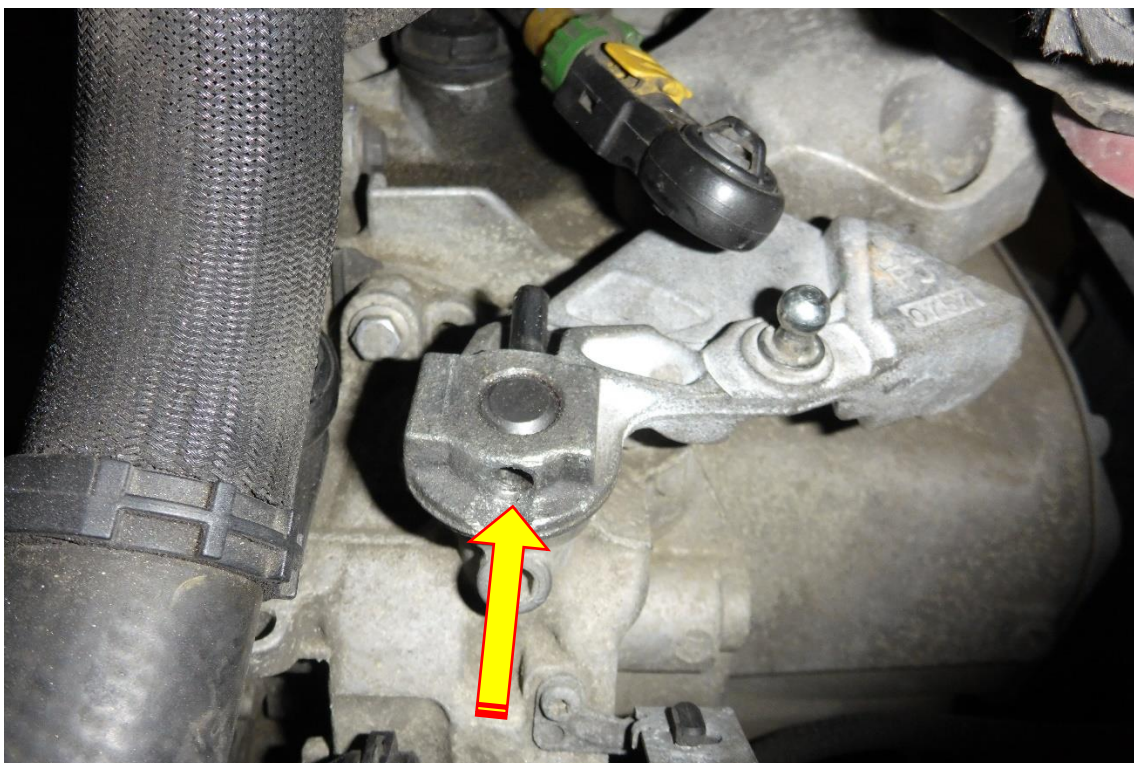
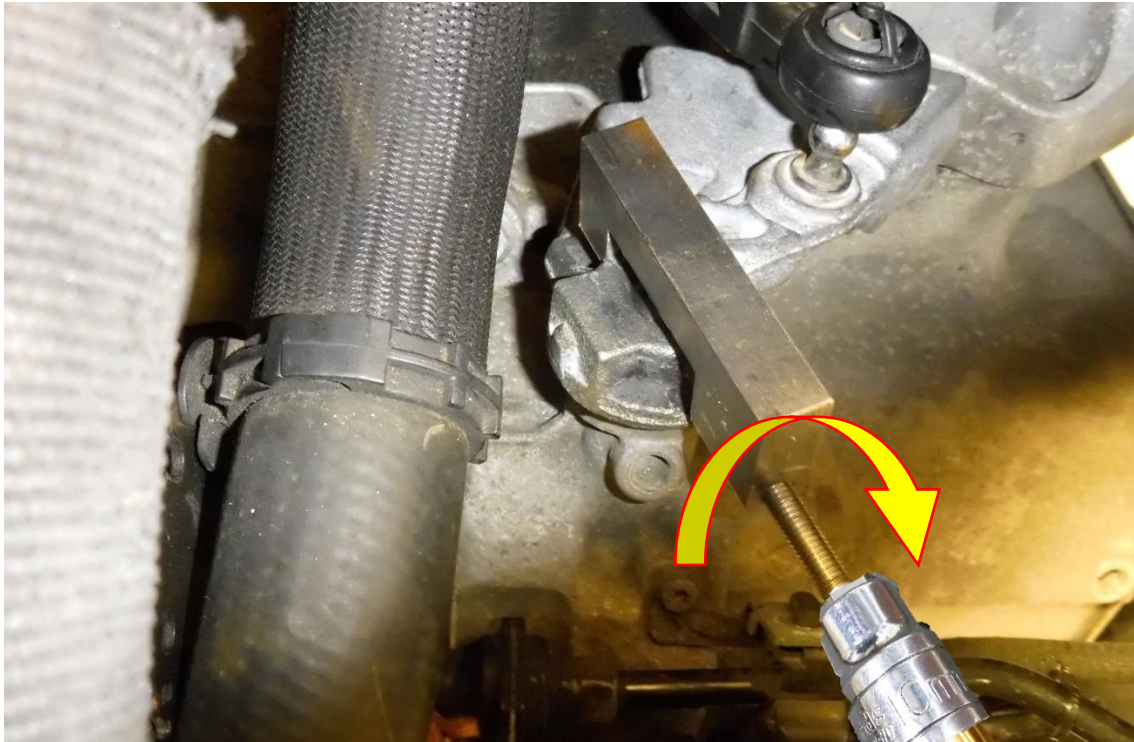

- Fit the ball pin to the Forge short shifter as illustrated below in step 8. Using a 16mm spanner tighten the ball pin in desired position along the adjustment slot. Take the Forge Motorsport Short shifter and place it onto the shaft, lining up the hole labelled below with the hole in the short shifter shaft. The orientation is illustrated below.

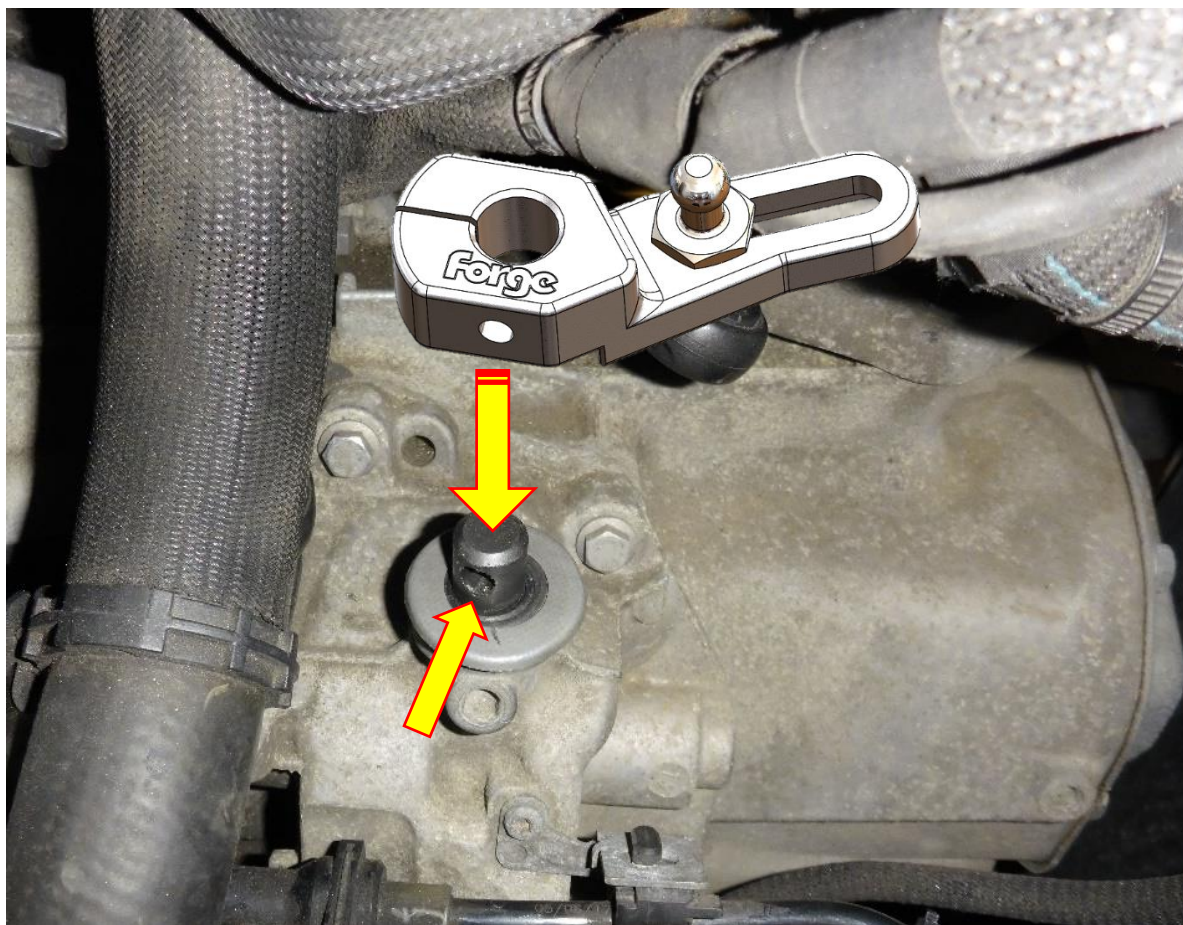

- Using a 10mm socket and suitable driver and a 10mm spanner attach the supplied M6 bolt, washers and nyloc nut through the hole in the shifter and shaft to secure the shifter as detailed below.

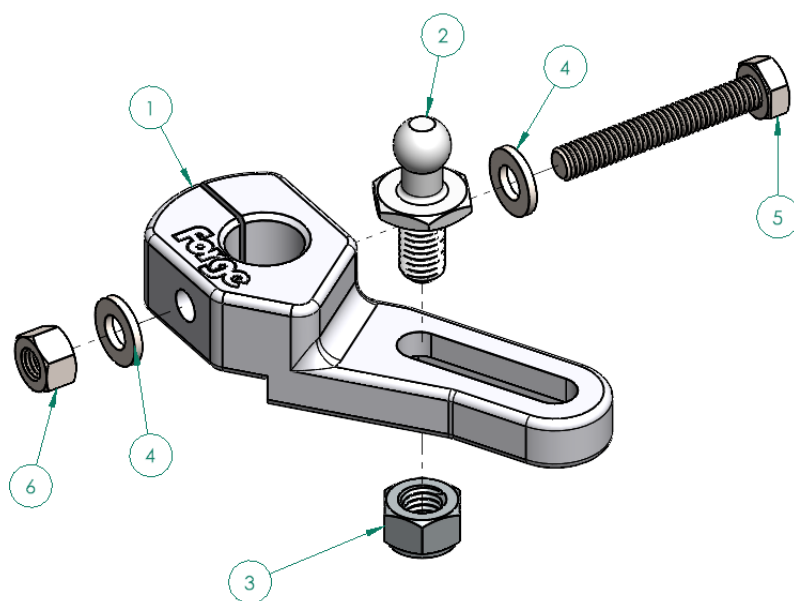

ITEM NO.	Description
1	SS6-B
2	10mm Ball Pin
3	M8 Nyloc Nut
4	M6 Washer
5	M6 X 40 Hex Bolt
6	M6 Nyloc Nut

9. Push the shifter cable over the ball pin to secure it. Check how the gear change feels inside the vehicle, if you feel it needs to be adjusted use a 16mm spanner to reposition the ball pin. Use the steps 1 to 3 in reverse to put the vehicle back together.



10. You have now successfully installed your Forge Motorsport short shifter, perform a final spanner and connections check. Now take your vehicle for a test drive and enjoy your new Forge Motorsport product.

For a full range of performance products for your vehicle.

If you have any questions or concerns about this product or anything else, please feel free to contact your local or preferred Forge Motorsport Dealer/Installer or you may contact us directly.

Forge Motorsport UK (+44)1452 380999
Forge Motorsport USA (407)-447-5363
Forge Motorsport ASIA +886-4-22516887

info@forgemotorsport.co.uk
sales@forgemotorsport.com
sales@forgemotorsport.asia

